



SPO# _____

CUSTOMER: _____

PROJECT: _____

TRANSFORMER PAD DETAILS

9'-6" x 9'-6" x 8"

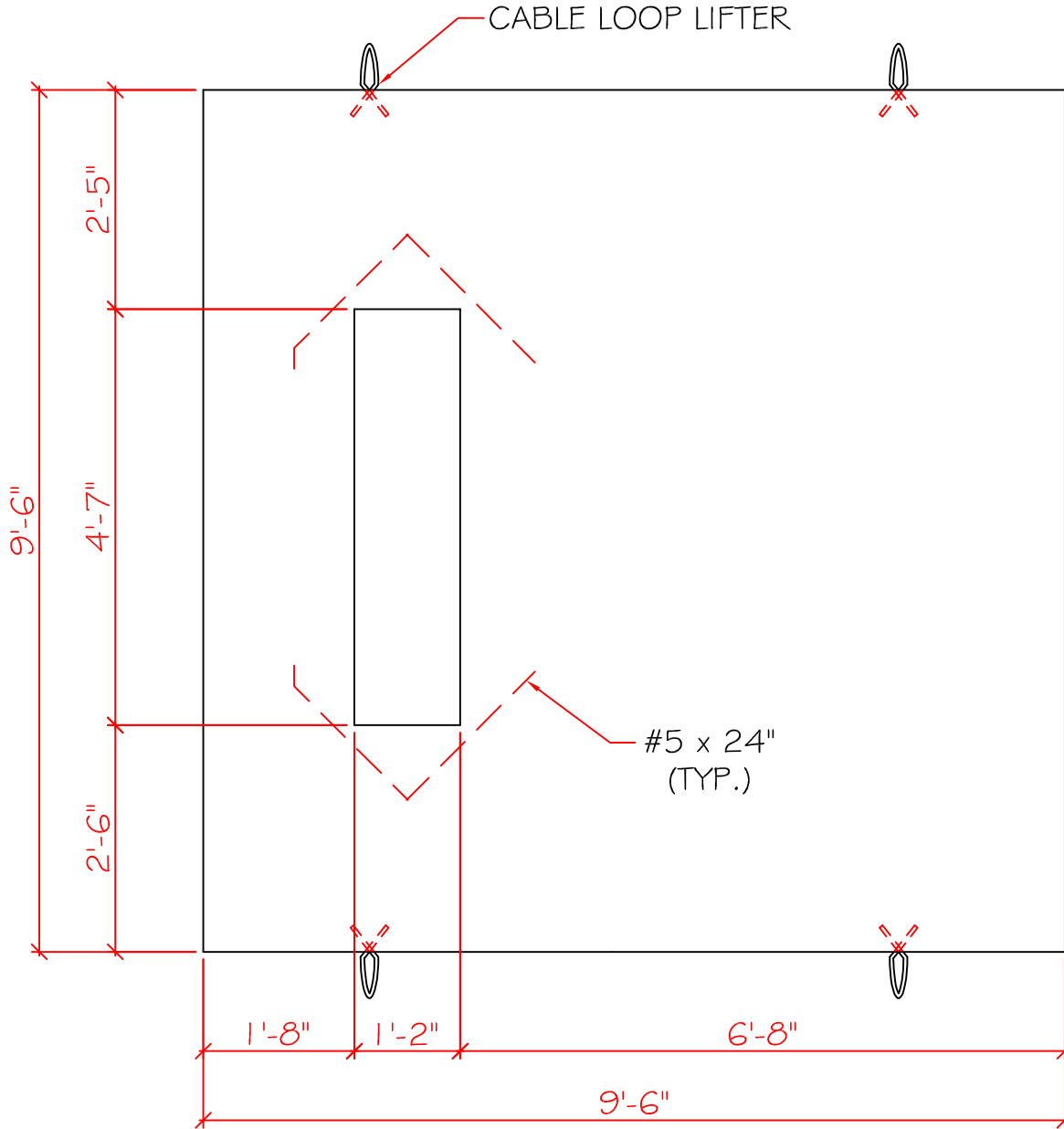

PLAN VIEW

TOOL OR
CHAMFER EDGES

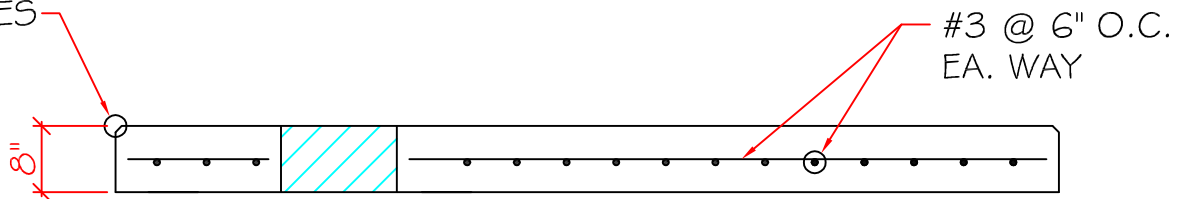

ELEVATION

UNITED PRECAST INC.
P.O. BOX 991
MT. VERNON, OHIO 43050