



SPO# _____

CUSTOMER: _____

PROJECT: _____

C.O.C. METER PIT DETAILS

2"Ø METER PIT

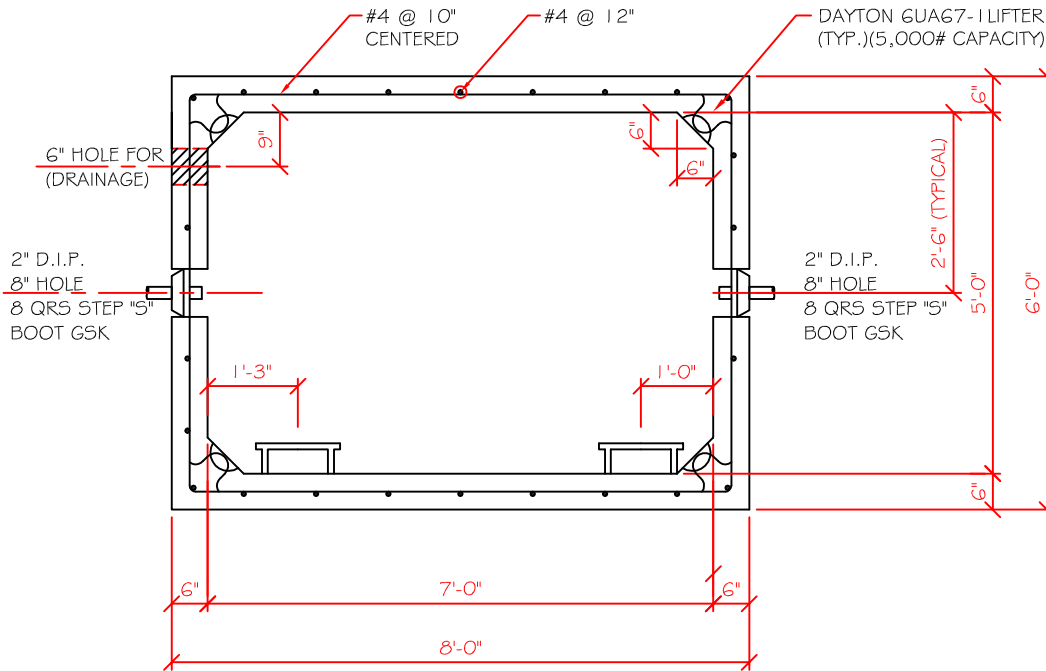

PLAN VIEW

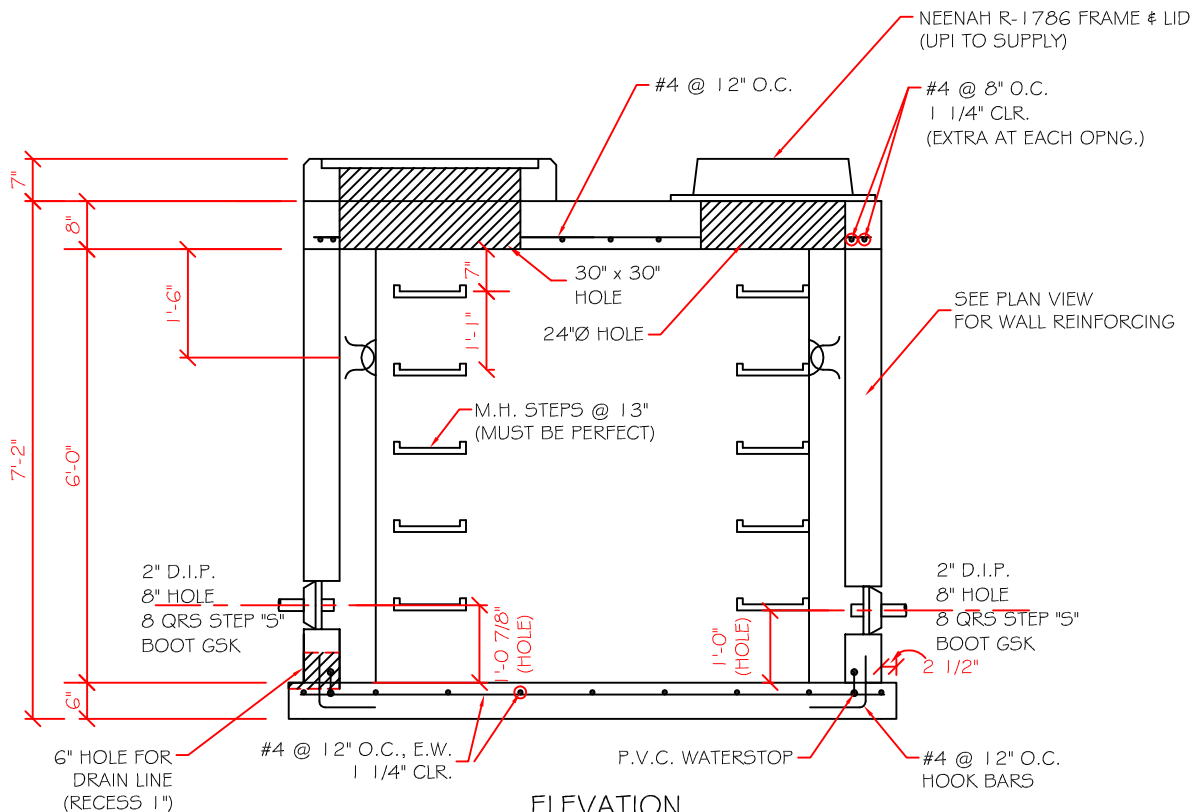

ELEVATION

UNITED PRECAST INC.
P.O. BOX 991
MT. VERNON, OHIO 43050